

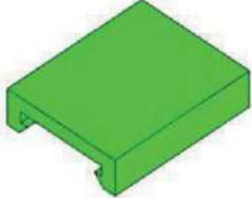

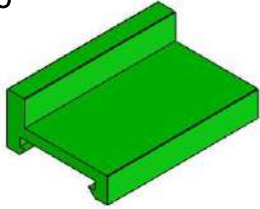

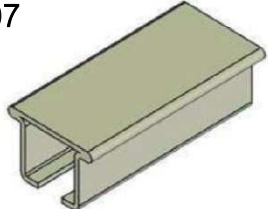

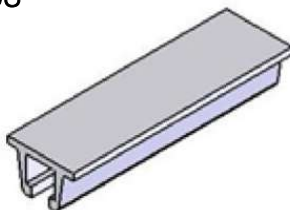

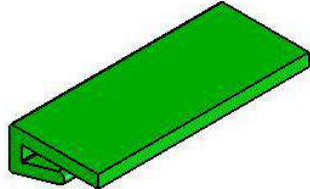
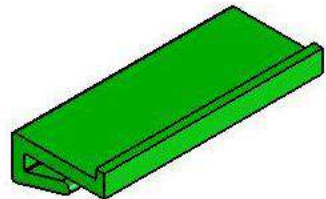
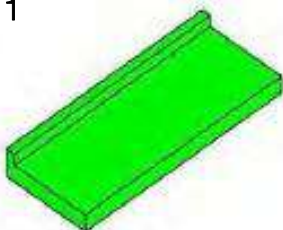
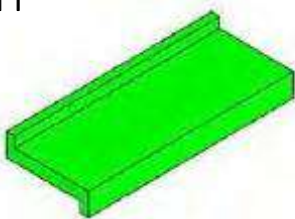

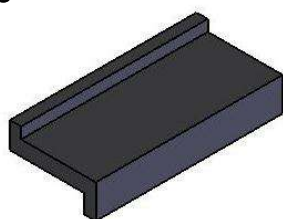
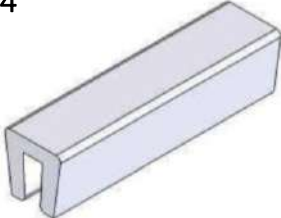
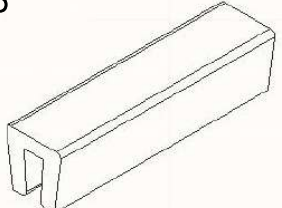
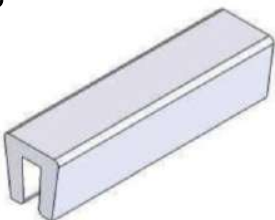
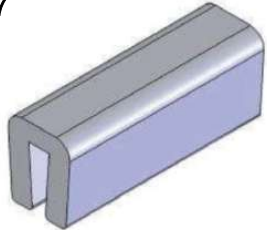
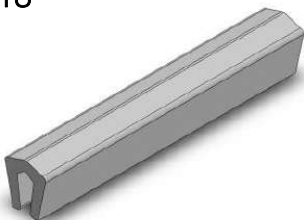
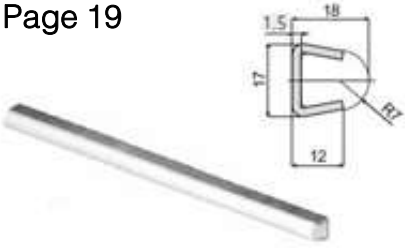
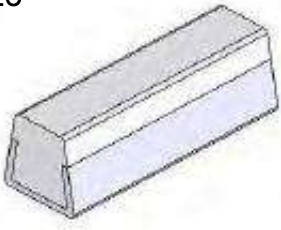
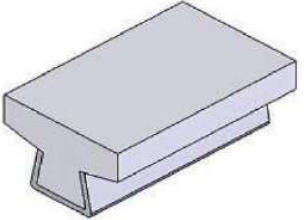
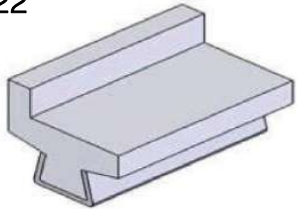
Profiles and Accessories

| | | |
|---|--|--|
| <p>Type C06 Page 05</p>  | <p>Type C06/S Page 06</p>  | <p>Type INOX4 AISI304 Type INOX4 AISI430 Page 07</p>  |
| <p>Type INOX4 ALUMUNIUUM Page 08</p>  | <p>Type P01 Page 09</p>  | <p>Type P02 Page 10</p>  |
| <p>Type L01 Page 11</p>  | <p>Type Z01 Page 11</p>  | <p>Type L02 Page 12</p>  |
| <p>Type Z02 Page 13</p>  | <p>Type U05 Page 14</p>  | <p>Type U05.5 Page 15</p>  |
| <p>Type U05.7 Page 16</p>  | <p>Type U07.7 Page 17</p>  | <p>Type U05 Pyramid Page 18</p>  |

| | | |
|--|--|---|
| <p>Type R01.1 Page 19</p>  | <p>Type R01.2 Page 20</p>  | <p>Type R02 Page 21</p>  |
| <p>Type R03 Page 22</p>  | <p>Spiral Profile Page 23</p>  | <p>Art. 609 Page 24</p>  |
| <p>Art. 608 Page 24</p>  | <p>Art. 678 Page 25</p>  | <p>Art. 610 Page 26</p>  |
| <p>Art. 775 Page 27</p>  | <p>Type MG01 Page 28</p>  | <p>Type MG02 Page 29</p>  |

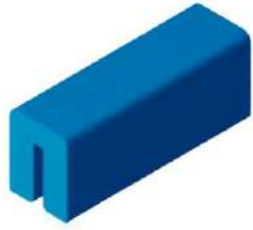
Guides and steel profiles

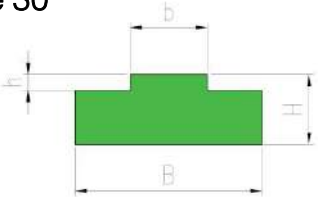
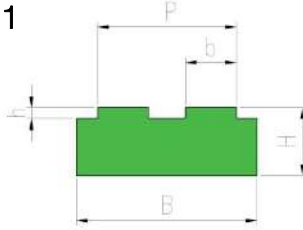
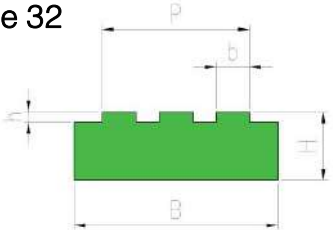
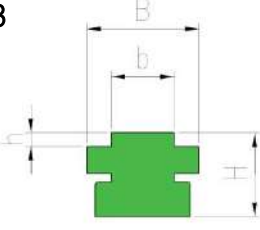
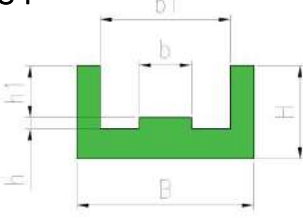
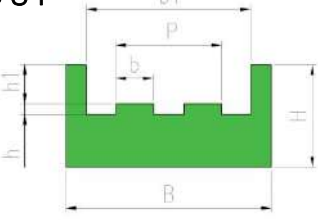
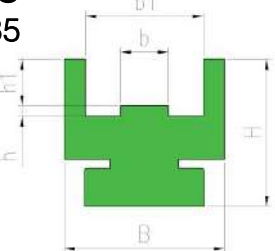
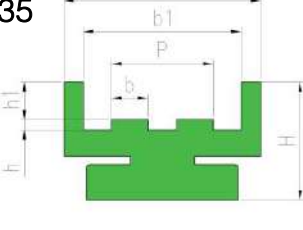
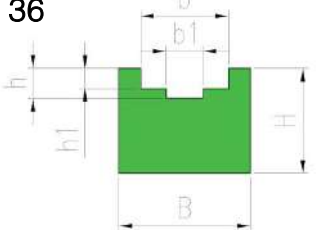
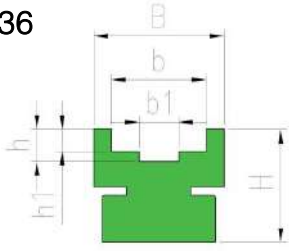
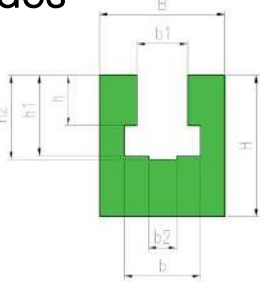
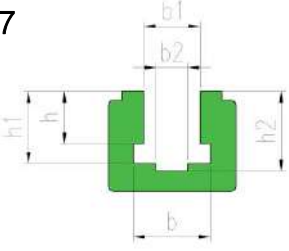
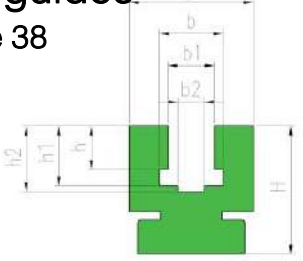
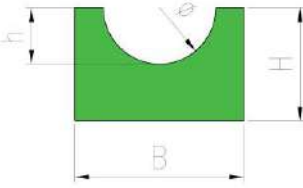
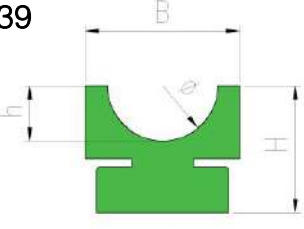
| | | |
|--|--|--|
| <p>T1 guides Page 30</p>  | <p>T2 guides Page 31</p>  | <p>T3 guides Page 32</p>  |
| <p>T1C guides Page 33</p>  | <p>E1 guides Page 34</p>  | <p>E2 guides Page 34</p>  |
| <p>E1C guides Page 35</p>  | <p>E2C guides Page 35</p>  | <p>U guides Page 36</p>  |
| <p>UC guides Page 36</p>  | <p>BL guides Page 37</p>  | <p>BLC guides Page 37</p>  |
| <p>KC guides Page 38</p>  | <p>R guides Page 39</p>  | <p>RC guides Page 39</p>  |

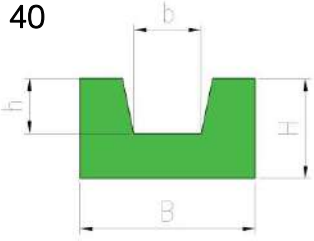
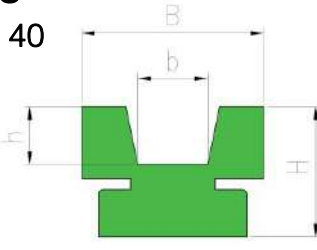
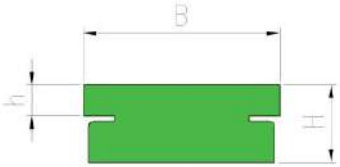
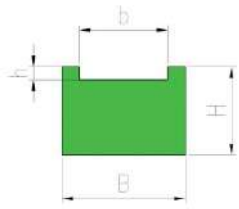
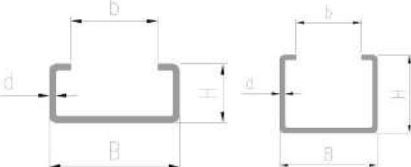
| | | |
|--|--|--|
| <p>V guides Page 40</p>  | <p>VC guides Page 40</p>  | <p>PC rails Page 41</p>  |
| <p>F/FC rails Page 41</p>  | <p>Steel Profiles Page 42</p>  | |

Type C06

Extruded Profiles C series

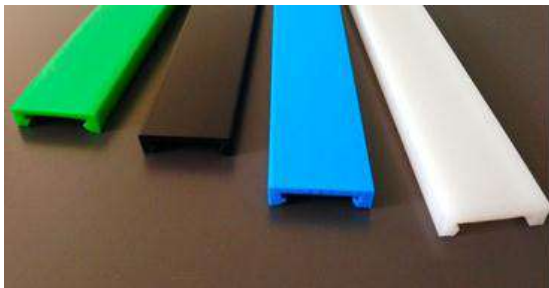
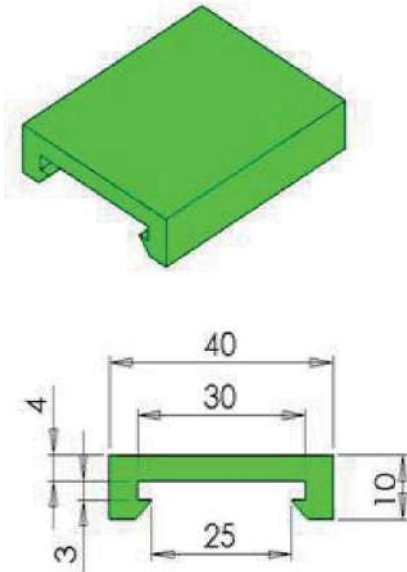

| | |
|------------|--|
| MATERIALS | PE-UHMW |
| FEATURES | Wearstrips or side guides |
| ON REQUEST | Other materials and colours 6mt bars (delivery for special lengths to be defined) |
| NOTE | Combination with metallic profiles INOX4 AISI 430/INOX4 AISI 304 INOX 4 ALLUMINIUM |

| Color | ITEM CODE | SUPPLY | MOQ |
|-------|--------------------|-----------|---------|
| Green | 93ITAUHMWM0305C06E | 3 mt Bars | 30 Bars |
| White | 93ITAUHMWM0305C06W | 3 mt Bars | 30 Bars |
| Black | 93ITAUHMWM0305C06K | 3 mt Bars | 30 Bars |

AVAILABILITY ON DEMAND IN BLUE LINE SECTION

| Color | ITEM CODE | SUPPLY | MOQ |
|-------|--------------------|-----------|---------|
| Blue | 93ITAUHMWM0305C06B | 3 mt Bars | 30 Bars |

Type C06/S

Extruded Profiles C series

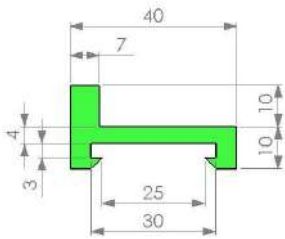
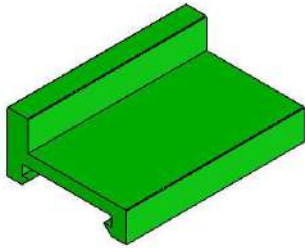

| | |
|------------|---|
| MATERIALS | PE-UHMW |
| FEATURES | Side wearstrips |
| ON REQUEST | Other materials and colours 6mt bars (delivery for special lengths to be defined) |
| NOTE | +20% for not complete supply unit Combination with metallic profiles INOX4 AISI 430/INOX4 AISI 304 INOX 4 ALLUMINIUM |

| Color | ITEM CODE | SUPPLY | MOQ |
|-------|---------------------|-----------|---------|
| Green | 931TAUHMWM0305C06SE | 3 mt Bars | 30 Bars |
| Black | 931TAUHMWM0305C06SK | 3 mt Bars | 30 Bars |

AVAILABILITY ON DEMAND

| | | | |
|-------|---------------------|-----------|---------|
| White | 931TAUHMWM0305C06SW | 3 mt Bars | 30 Bars |
| Blue* | 931TAUHMWM0305C06SB | 3 mt Bars | 30 Bars |

*AVAILABILITY ON DEMAND IN BLUE LINE SECTION

Type INOX4 AISI304
Type INOX4 AISI430

Metallic Profiles

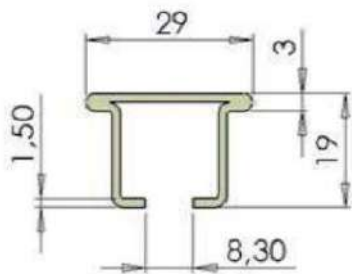
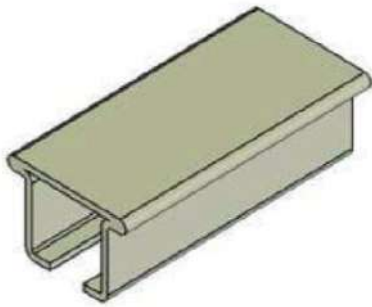

| | |
|------------|--|
| MATERIALS | INOX4 AISI 304 INOX4 AISI 430 |
| FEATURES | Metallic support for wearstrips to be assembled with C06, C06/S, C07, U01.1, W05 |
| ON REQUEST | Other materials and colours 6mt bars (delivery for special lengths to be defined) Galvanized |
| NOTE | +20% for not complete supply unit |

| Color | ITEM CODE | SUPPLY | MOQ |
|----------|--------------------|-----------|---------|
| AISI 430 | 93ITASS430M03INOX4 | 3 mt bars | 30 Bars |
| AISI 304 | 93ITASS304M03INOX4 | 3 mt bars | 30 Bars |

Type INOX4 ALUMINIUM

Metallic Profiles

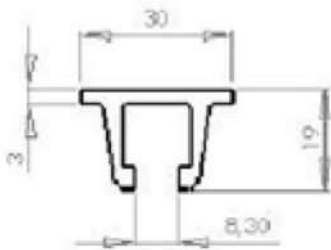
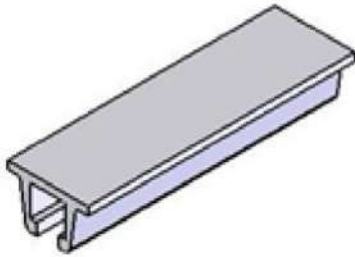

| | |
|------------|--|
| MATERIALS | ALUMINIUM |
| FEATURES | Metallic support for wearstrips to be assembled with C06, C06/S, C07, U01.1, W05 |
| ON REQUEST | 6 mt bars (delivery for special lengths to be defined) |
| NOTE | +20% for not complete supply unit |

| Color | ITEM CODE | SUPPLY | MOQ |
|-----------|------------------|-----------|---------|
| ALUMINIUM | 93ITAALUM03INOX4 | 3 mt bars | 30 Bars |

Type P01

Extruded Profiles P series

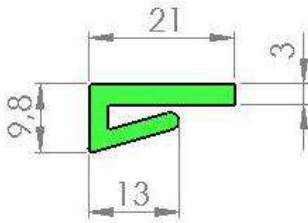
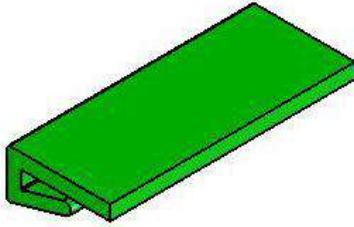

| | |
|------------|---|
| MATERIALS | PE-UHMW |
| FEATURES | Side wearstrips Available for 820, 880TAB |
| ON REQUEST | Other materials and colours Bars or rolls of different lengths |
| NOTE | +20% for not complete supply unit |

| Color | ITEM CODE | SUPPLY | MOQ |
|-------|------------------|--------|--------|
| Green | 93ITAUHMWR50P01E | Roll | 100 mt |
| Black | 93ITAUHMWR50P01K | Roll | 100 mt |

AVAILABILITY ON DEMAND

| | | | |
|-------|------------------|------|--------|
| White | 93ITAUHMWR50P01W | Roll | 100 mt |
| Blue* | 93ITAUHMWR50P01B | Roll | 100 mt |

*AVAILABILITY ON DEMAND IN BLUE LINE SECTION

Type P02

Extruded Profiles P series

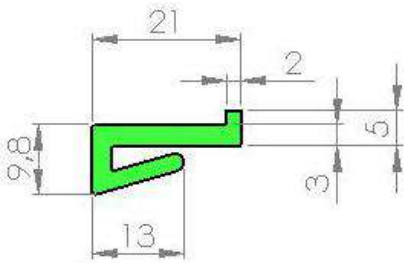
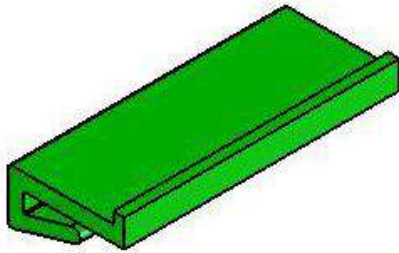

| | |
|------------|---|
| MATERIALS | PE-UHMW |
| FEATURES | Side wearstrips with side edge Available for 820, 880TAB |
| ON REQUEST | Other materials and colours Bars or rolls of different lengths |
| NOTE | +20% for not complete supply unit |

| Color | ITEM CODE | SUPPLY | MOQ |
|-------|------------------|--------|--------|
| Green | 931TAUHMWR50P02E | Roll | 100 mt |
| Black | 931TAUHMWR50P02K | Roll | 100 mt |

AVAILABILITY ON DEMAND

| | | | |
|-------|------------------|------|--------|
| White | 931TAUHMWR50P02W | Roll | 100 mt |
| Blue* | 931TAUHMWR50P02B | Roll | 100 mt |

*AVAILABILITY ON DEMAND IN BLUE LINE SECTION

Type L01

Extruded Profiles L series

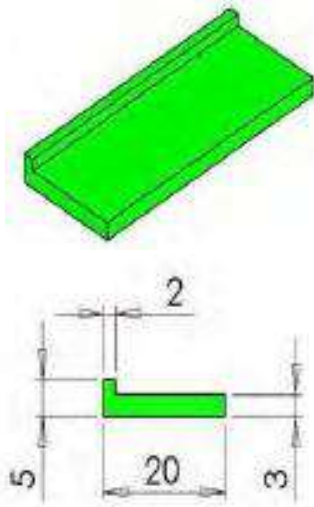

| | |
|------------|---|
| MATERIALS | PE-UHMW |
| FEATURES | Side wearstrips with side edge |
| ON REQUEST | Other materials and colours Bars or rolls of different lengths |
| NOTE | +20% for not complete supply unit |

| Color | ITEM CODE | SUPPLY | MOQ |
|-------|-----------------|--------|-------------|
| Green | 931TAUHMR60L01E | Rolls | 100mt rolls |

Type Z01

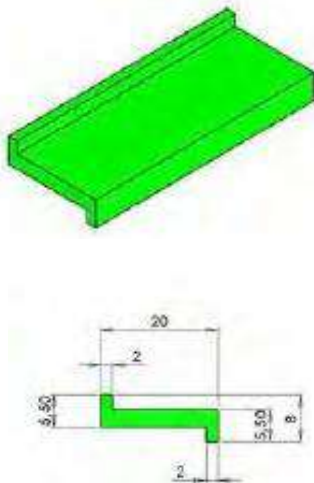

| | |
|------------|--|
| MATERIALS | PE-UHMW |
| FEATURES | Side wearstrips with side edge. |
| ON REQUEST | Other materials and colours. Bars or rolls of different lengths . |
| NOTE | +20% for not complete supply unit |

| Color | ITEM CODE | SUPPLY | MOQ |
|-------|------------------|--------|-------------|
| Green | 931TAUHMWR50Z01E | Rolls | 100mt rolls |

Type L02

Extruded Profiles L series

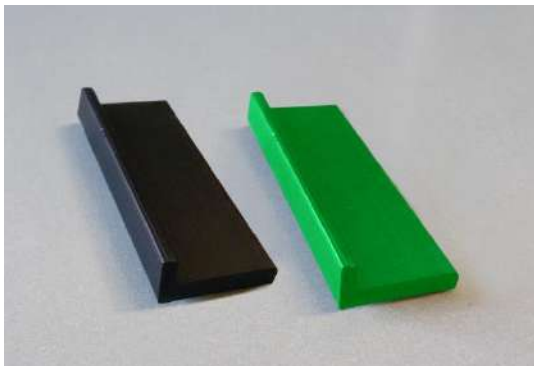
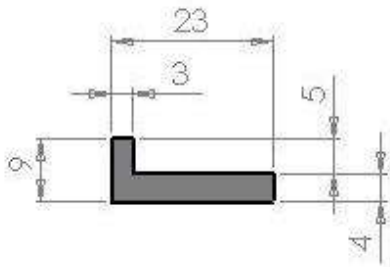
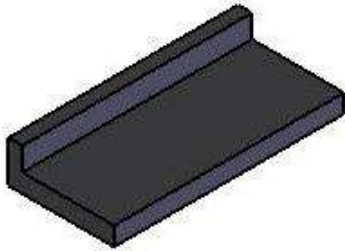

| | |
|------------|---|
| MATERIALS | PE-UHMW |
| FEATURES | Side wearstrips with side edge Available for 879, 831 TAB |
| ON REQUEST | Other materials and colours Bars or rolls of different lengths |
| NOTE | +20% for not complete supply unit |

| Color | ITEM CODE | SUPPLY | MOQ |
|-------|------------------|--------|--------|
| Green | 931TAUHMWR50L02E | Roll | 100 mt |
| Black | 931TAUHMWR50L02K | Roll | 100 mt |

Type U05

Extruded Profiles U series

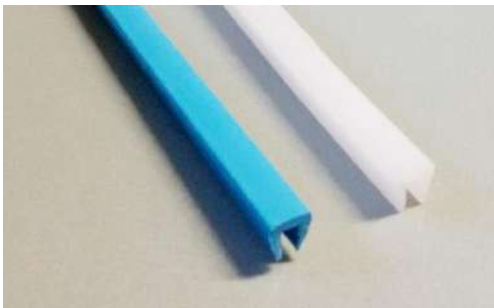
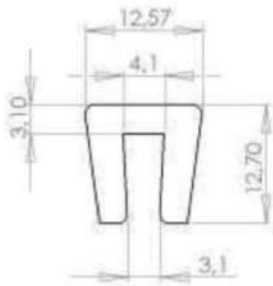
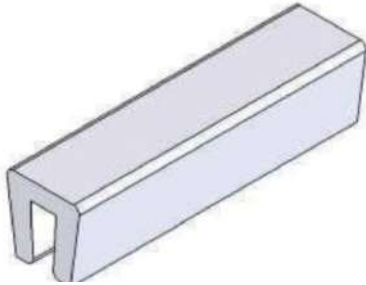

| | |
|------------|---|
| MATERIALS | PE-UHMW |
| FEATURES | Snapped wearstrips |
| ON REQUEST | Other materials and colours Bars or rolls of different lengths |
| NOTE | +20% for not complete supply unit |

| Color | ITEM CODE | SUPPLY | MOQ |
|-------|------------------|--------|-------------|
| White | 93ITAUHMWR50U05W | Roll | 50 mt rolls |

AVAILABILITY ON DEMAND IN BLUE LINE SECTION

| | | | |
|------|------------------|------|-------------|
| Blue | 93ITAUHMWR50U05B | Roll | 50 mt rolls |
|------|------------------|------|-------------|

Type U05.5

Extruded Profiles U series

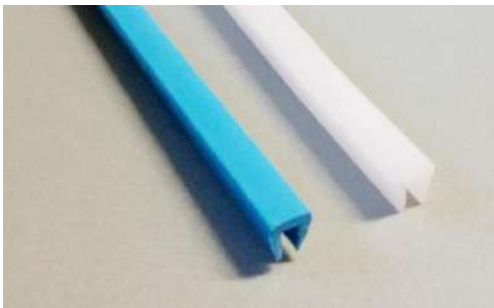
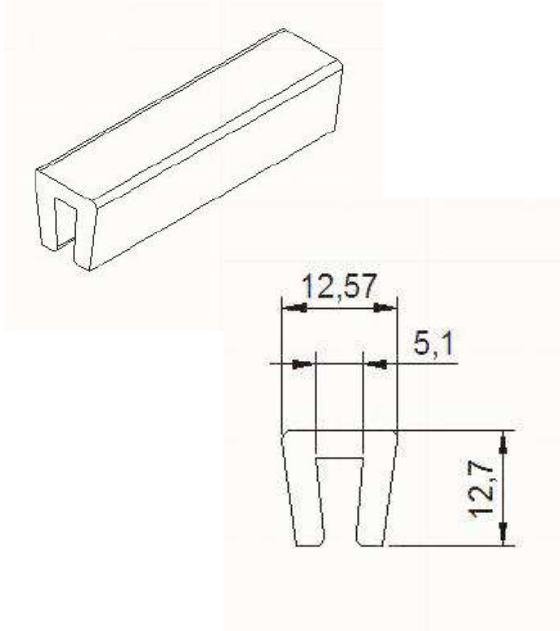

| | |
|------------|---|
| MATERIALS | PE-UHMW |
| FEATURES | Snapped wearstrips |
| ON REQUEST | Other materials and colours Bars or rolls of different lengths |
| NOTE | +20% for not complete supply unit |

| Color | ITEM CODE | SUPPLY | MOQ |
|-------|-------------------|--------|-------------|
| White | 931TAUHMWR50U055W | Roll | 50 mt rolls |

AVAILABILITY ON DEMAND IN BLUE LINE SECTION

| | | | |
|------|-------------------|------|-------------|
| Blue | 931TAUHMWR50U055B | Roll | 50 mt rolls |
|------|-------------------|------|-------------|

Type U05.7

Extruded Profiles U series

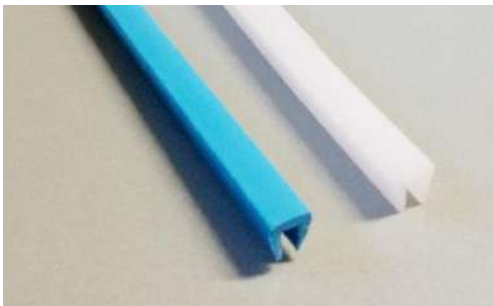
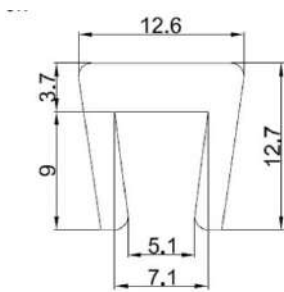
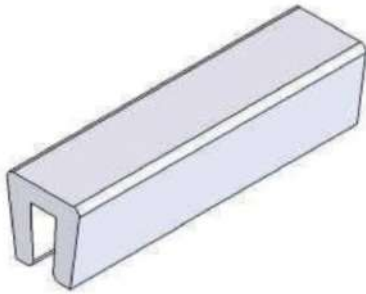

| | |
|------------|---|
| MATERIALS | PE-UHMW |
| FEATURES | Snapped wearstrips |
| ON REQUEST | Other materials and colours Bars or rolls of different lengths |
| NOTE | +20% for not complete supply unit |

| Color | ITEM CODE | SUPPLY | MOQ |
|-------|-------------------|--------|-------------|
| White | 931TAUHMWR50U057W | Roll | 50 mt rolls |

AVAILABILITY ON DEMAND IN BLUE LINE SECTION

| | | | |
|------|-------------------|------|-------------|
| Blue | 931TAUHMWR50U057B | Roll | 50 mt rolls |
|------|-------------------|------|-------------|

Type U07.7

Extruded Profiles U series

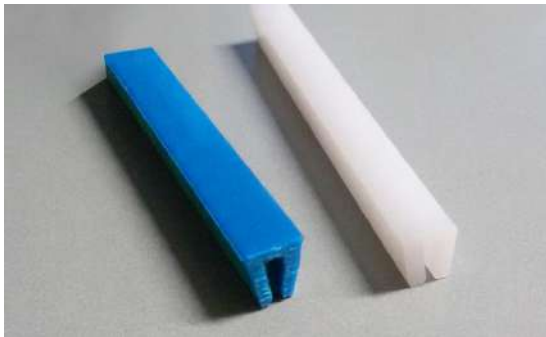
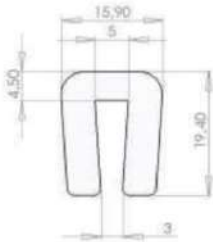
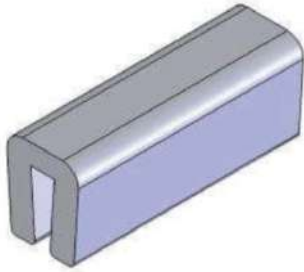

| | |
|------------|---|
| MATERIALS | PE-UHMW |
| FEATURES | Snapped wearstrips |
| ON REQUEST | Other materials and colours Bars or rolls of different lengths |
| NOTE | +20% for not complete supply unit |

| Color | ITEM CODE | SUPPLY | MOQ |
|-------|----------------|-----------|---------|
| White | 93ITAPEM3U077W | 3 mt bars | 30 Bars |

AVAILABILITY ON DEMAND IN BLUE LINE SECTION

| | | | |
|------|----------------|-----------|---------|
| Blue | 93ITAPEM3U077B | 3 mt bars | 30 Bars |
|------|----------------|-----------|---------|

Type U05 Pyramid

Extruded Profiles U series

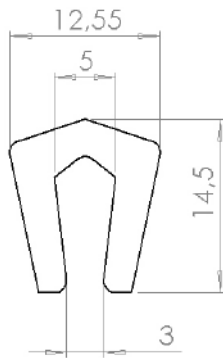
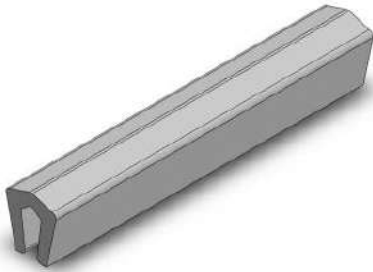

| | |
|------------|---|
| MATERIALS | PE-UHMW |
| FEATURES | Snapped wearstrips |
| ON REQUEST | Other materials and colours Bars or rolls of different lengths |
| NOTE | +20% for not complete supply unit |

| Color | ITEM CODE | SUPPLY | MOQ |
|-------|-------------------|--------|-------------|
| White | 931TAUHMWR50U05CW | Roll | 50 mt rolls |

AVAILABILITY ON DEMAND IN BLUE LINE SECTION

| | | | |
|------|-------------------|------|-------------|
| Blue | 931TAUHMWR50U05CB | Roll | 50 mt rolls |
|------|-------------------|------|-------------|

Type R01.1

Extruded Profiles R series

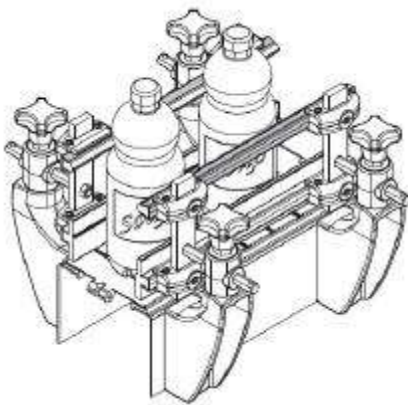
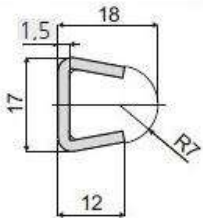

Application

| | |
|------------|---|
| MATERIALS | PE-UHMW,+ base profile material AISI304 |
| FEATURES | Conical side guides |
| ON REQUEST | Other materials and colours 6mt bars (delivery for special lengths to be defined) |
| NOTE | +20% for not complete supply unit |

| Color | ITEM CODE | SUPPLY | MOQ |
|-------|-------------------|-----------|---------|
| White | 93ITAUHMWR06R011W | 3 mt Bars | 30 Bars |

Type R01.2

Extruded Profiles R series

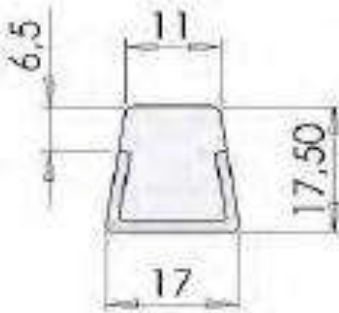
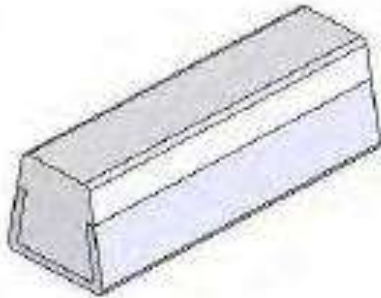

| | |
|------------|---|
| MATERIALS | PE-UHMW,+ base profile material AISI304 |
| FEATURES | Flat side guides |
| ON REQUEST | Other materials and colours 6mt bars (delivery for special lengths to be defined) |
| NOTE | +20% for not complete supply unit |

| Color | ITEM CODE | SUPPLY | MOQ |
|-------|-------------------|-----------|---------|
| White | 931TAUHMWR06R012W | 3 mt Bars | 30 Bars |

Type R02

Extruded Profiles R series

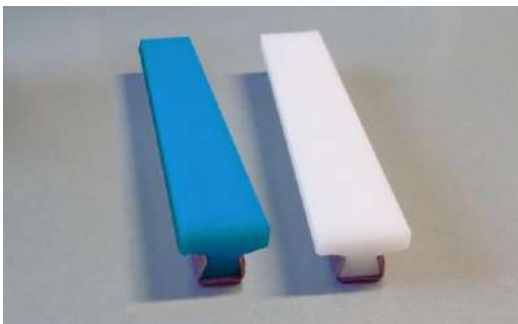
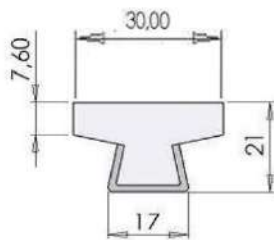
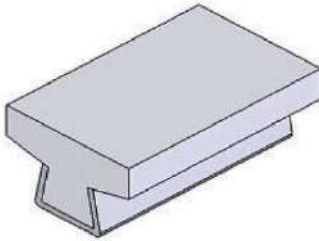

| | |
|------------|---|
| MATERIALS | PE-UHMW, stainless steel metallic profile (AISI304) |
| FEATURES | Conical guide rail and wearstrips for belt. |
| ON REQUEST | Other materials and colours 6mt bars (delivery for special lengths to be defined) |
| NOTE | Metallic base profile 1.5mm thickness |

| Color | ITEM CODE | SUPPLY | MOQ |
|---------|------------------|-----------|----------|
| Natural | 931TAUHMWM03R02N | 3 mt bars | No min.Q |

AVAILABILITY ON DEMAND IN BLUE LINE SECTION

| | | | |
|------|------------------|-----------|----------|
| Blue | 931TAUHMWM03R02B | 3 mt bars | No min.Q |
|------|------------------|-----------|----------|

Type R03

Extruded Profiles R series

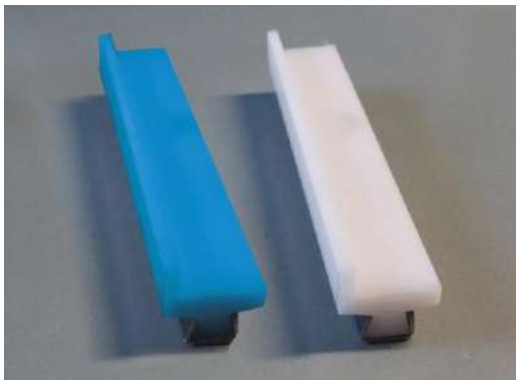
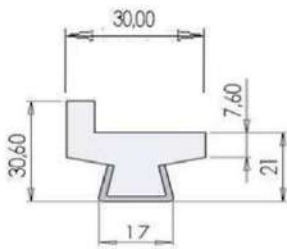
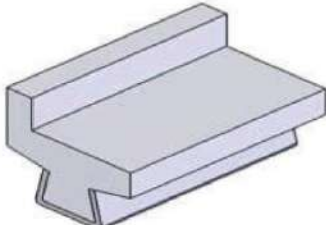

| | |
|------------|---|
| MATERIALS | PE-UHMW, stainless steel metallic profile (AISI 304) |
| FEATURES | Conical guide rail and wearstrips for belt with edge strip |
| ON REQUEST | Other materials and colours 6mt bars (delivery for special lengths to be defined) |
| NOTE | Metallic base profile 1.5mm thickness |

| Color | ITEM CODE | SUPPLY | MOQ |
|---------|------------------|-----------|----------|
| Natural | 931TAUHMWM03R03N | 3 mt bars | No min.Q |

AVAILABILITY ON DEMAND IN BLUE LINE SECTION

| | | | |
|------|------------------|-----------|----------|
| Blue | 931TAUHMWM03R03B | 3 mt bars | No min.Q |
|------|------------------|-----------|----------|

Spiral profile

Extruded Profiles

- U05
- U05.5
- U05.7
- U07.7

Suitable for carryway, for cage in spirals.
Suitable for Flex One belt in:



Solid configuration



Semicompact configuration



Extruded solid configuration



Art. 609

Profiles Accessories

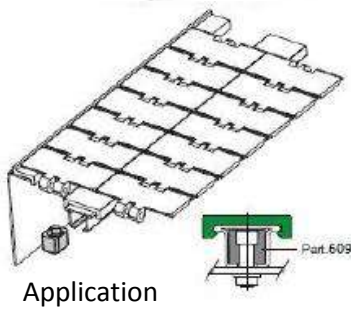
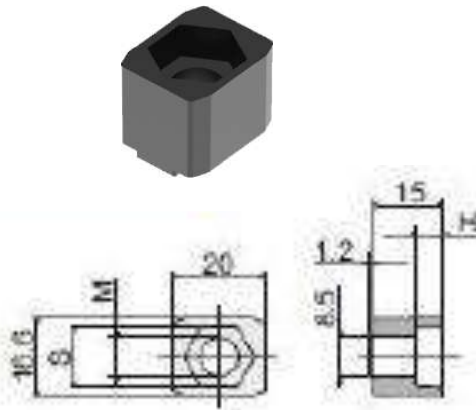

| | |
|-----------|--|
| MATERIALS | Reinforced polyamide, black |
| FEATURES | Mounting block for INOX4 profile used to assemble guides on the frames |
| NOTE | Suitable for INOX4 AISI304 – AISI430 |

| ITEM CODE | M | S | SUPPLY | MOQ |
|-----------|----|----|--------|----------|
| 609/15833 | M6 | 10 | pieces | No min.Q |
| 609/15832 | M8 | 13 | pieces | No min.Q |

Art. 608

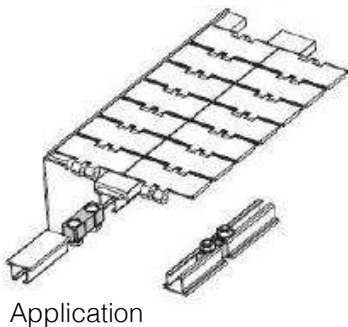
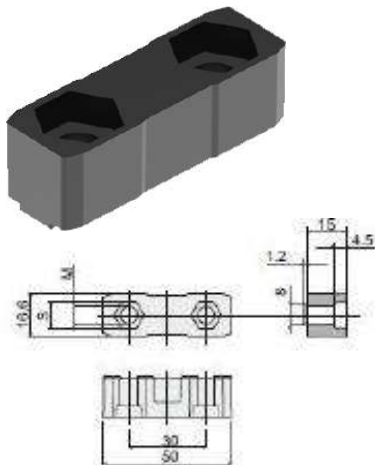

| | |
|-----------|--|
| MATERIALS | Reinforced polyamide, black |
| FEATURES | Connecting block for INOX4 profile used to connect 2 different parts |
| NOTE | Suitable for INOX4 AISI304 – AISI430 |

| ITEM CODE | M | S | SUPPLY | MOQ |
|-----------|----|----|--------|----------|
| 608/15831 | M6 | 10 | pieces | No min.Q |
| 608/15830 | M8 | 13 | pieces | No min.Q |

Art. 678

Profiles Accessories

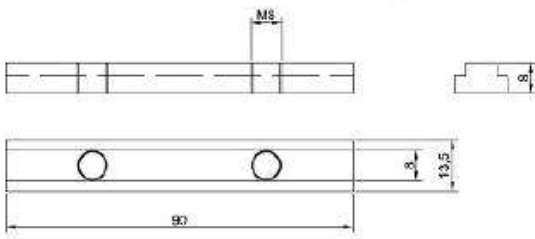
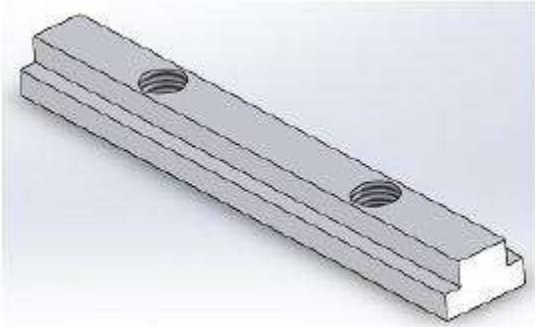

| | |
|-----------|--|
| MATERIALS | Stainless steel |
| FEATURES | Connecting block for chain guide type INOX4 ALUMINIUM. |
| NOTE | Suitable for INOX4 ALUMINIUM Screw included |

| ITEM CODE | M | SUPPLY | MOQ |
|--------------|----|--------|----------|
| 678/678697 A | M8 | pieces | No min.Q |

Art. 610

Profiles Accessories

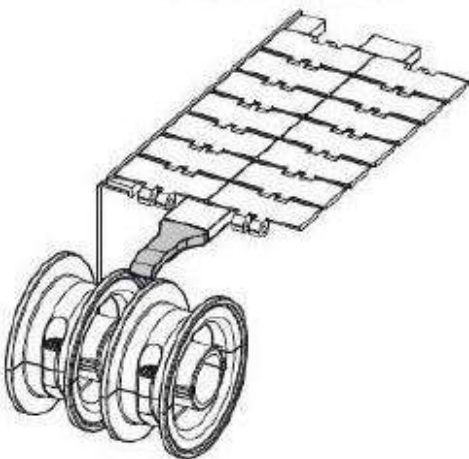
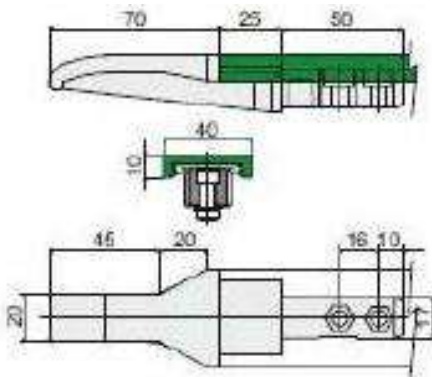

Application

| | |
|-----------|---|
| MATERIALS | Shoe in black polyamide |
| FEATURES | Chain inlet guide shoe To be assembled near the idler wheels to drive the chain on the transport guide |
| NOTE | Suitable ONLY for INOX4 AISI304 – AISI430 |

| ITEM CODE | SUPPLY | MOQ |
|-----------|--------|----------|
| 610/15834 | pieces | No min.Q |

Art. 775

Profiles Accessories

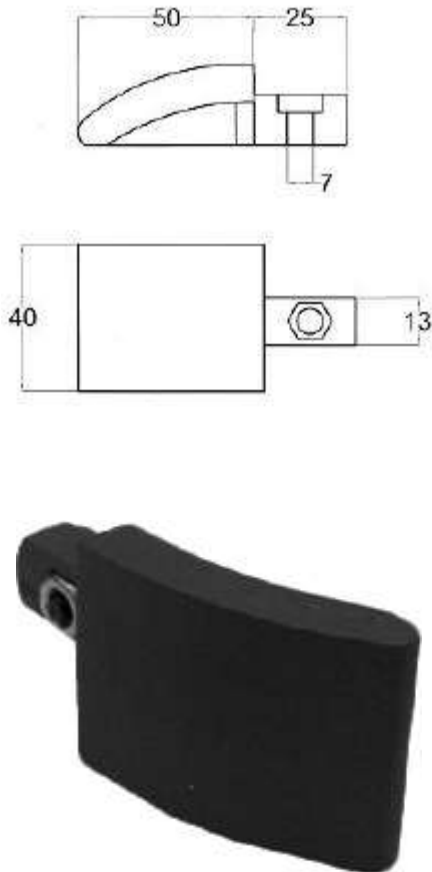

| | |
|-----------|--|
| MATERIALS | Shoe in grey polyamide. |
| FEATURES | To be assembled near to the idler wheels to drive the chain on the transport guide |
| NOTE | Suitable ONLY for INOX4 ALUMINIUM Nut and screw included |

| ITEM CODE | SUPPLY | MOQ |
|--------------|--------|----------|
| 775/775483 A | pieces | No min.Q |

Type MG01

Machined Profiles

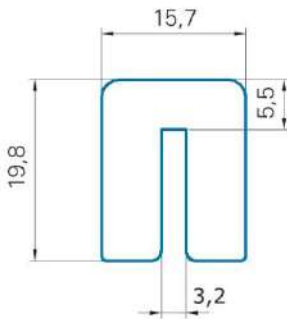
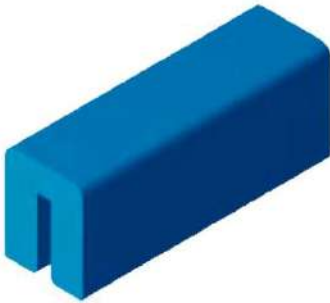

| | |
|------------|---|
| MATERIALS | PE-UHMW |
| FEATURES | Snapped wearstrips |
| ON REQUEST | Other materials and colours Bars or rolls of different lengths |
| NOTE | +20% for not complete supply unit |

| Color | ITEM CODE | SUPPLY | MOQ |
|-------|-------------------|-----------|---------|
| White | 93ITAUHMWM03MG01W | 3 mt bars | 30 Bars |
| Blue | 93ITAUHMWM03MG01B | 3 mt bars | 30 Bars |

Type MG02

Machined Profiles

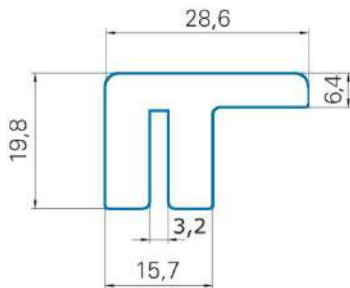
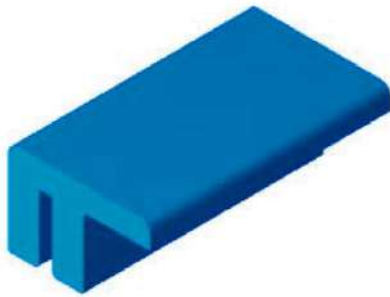

| | |
|------------|---|
| MATERIALS | PE-UHMW |
| FEATURES | Snapped wearstrips |
| ON REQUEST | Other materials and colours Bars or rolls of different lengths |
| NOTE | +20% for not complete supply unit |

| Color | ITEM CODE | SUPPLY | MOQ |
|-------|-------------------|-----------|---------|
| White | 93ITAUHMWM03MG02W | 3 mt bars | 30 Bars |
| Blue | 93ITAUHMWM03MG02B | 3 mt bars | 30 Bars |

T1 guides for single roller chains

Guides for roller chains

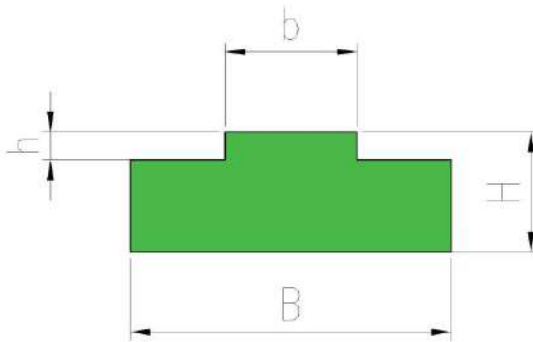

ISO chains

| Type | Chain | Ref. ISO | B [mm] | H [mm] | b [mm] | h [mm] |
|---------|-------------|----------|--------|--------|--------|--------|
| T1-MG01 | 3/8"x7/32" | 06-B1 | 15 | 10 | 5,4 | 1,5 |
| T1-MG05 | 1/2"x5/16" | 08-B1 | 20 | 10 | 7,4 | 2,2 |
| T1-MG06 | 1/2"x5/16" | 08-B1 | 20 | 15 | 7,4 | 2,2 |
| T1-MG07 | 1/2"x5/16" | 08-B1 | 20 | 20 | 7,4 | 2,2 |
| T1-MG09 | 5/8"x3/8" | 10-B1 | 20 | 10 | 9,2 | 2,6 |
| T1-MG10 | 5/8"x3/8" | 10-B1 | 20 | 15 | 9,2 | 2,6 |
| T1-MG11 | 5/8"x3/8" | 10-B1 | 20 | 20 | 9,2 | 2,6 |
| T1-MG13 | 3/4"x7/16" | 12-B1 | 25 | 10 | 11,3 | 2,4 |
| T1-MG14 | 3/4"x7/16" | 12-B1 | 25 | 15 | 11,3 | 2,4 |
| T1-MG15 | 3/4"x7/16" | 12-B1 | 25 | 20 | 11,3 | 2,4 |
| T1-MG18 | 1"x17mm | 16-B1 | 40 | 15 | 16,5 | 3,5 |
| T1-MG19 | 1"x17mm | 16-B1 | 40 | 20 | 16,5 | 3,5 |
| T1-MG21 | 1 1/4"x3/4" | 20-B1 | 45 | 15 | 19 | 4,3 |
| T1-MG22 | 1 1/4"x3/4" | 20-B1 | 45 | 20 | 19 | 4,3 |
| T1-MG24 | 1 1/2"x1" | 24-B1 | 60 | 15 | 24,6 | 5,6 |
| T1-MG25 | 1 1/2"x1" | 24-B1 | 60 | 20 | 24,6 | 5,6 |
| T1-MG27 | 1 3/4"x31mm | 28-B1 | 75 | 20 | 30 | 6,9 |
| T1-MG30 | 2"x31mm | 32-B1 | 80 | 20 | 30 | 7,8 |

ASA chains

| Type | Chain | Ref. ASA | B [mm] | H [mm] | b [mm] | h [mm] |
|---------|------------|----------|--------|--------|--------|--------|
| T1-MG51 | 3/8"x3/16" | ASA35 | 15 | 10 | 4 | 2,2 |
| T1-MG54 | 1/2"x5/16" | ASA40 | 20 | 10 | 7,1 | 2,3 |
| T1-MG55 | 1/2"x5/16" | ASA40 | 20 | 15 | 7,1 | 2,3 |
| T1-MG56 | 1/2"x5/16" | ASA40 | 20 | 20 | 7,1 | 2,3 |
| T1-MG58 | 5/8"x3/8" | ASA50 | 20 | 10 | 8,6 | 2,7 |
| T1-MG59 | 5/8"x3/8" | ASA50 | 20 | 15 | 8,6 | 2,7 |
| T1-MG60 | 5/8"x3/8" | ASA50 | 20 | 20 | 8,6 | 2,7 |
| T1-MG62 | 3/4"x1/2" | ASA60 | 25 | 10 | 11,9 | 3,4 |
| T1-MG63 | 3/4"x1/2" | ASA60 | 25 | 15 | 11,9 | 3,4 |
| T1-MG64 | 3/4"x1/2" | ASA60 | 25 | 20 | 11,9 | 3,4 |
| T1-MG66 | 1"x5/8" | ASA80 | 40 | 15 | 15,1 | 4,5 |
| T1-MG68 | 1"x5/8" | ASA80 | 40 | 20 | 15,1 | 4,5 |

T2 guides for double roller chains

Guides for roller chains

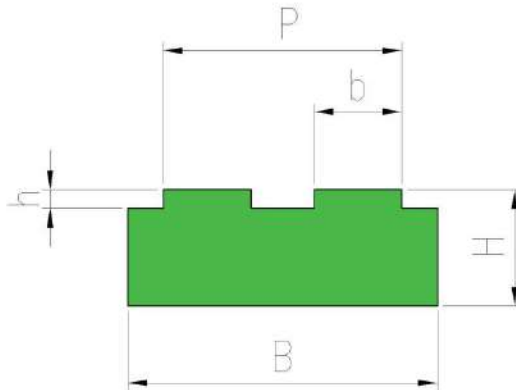

ISO chains

| Type | Chain | Ref. ISO | B [mm] | H [mm] | b [mm] | h [mm] | P [mm] |
|---------|-------------|----------|--------|--------|--------|--------|--------|
| T2-MG01 | 3/8"x7/32" | 06-B2 | 25 | 10 | 5,4 | 1,5 | 15,8 |
| T2-MG05 | 1/2"x5/16" | 08-B2 | 35 | 10 | 7,4 | 2,2 | 21,4 |
| T2-MG06 | 1/2"x5/16" | 08-B2 | 35 | 15 | 7,4 | 2,2 | 21,4 |
| T2-MG07 | 1/2"x5/16" | 08-B2 | 35 | 20 | 7,4 | 2,2 | 21,4 |
| T2-MG09 | 5/8"x3/8" | 10-B2 | 40 | 10 | 9,2 | 2,6 | 25,8 |
| T2-MG10 | 5/8"x3/8" | 10-B2 | 40 | 15 | 9,2 | 2,6 | 25,8 |
| T2-MG11 | 5/8"x3/8" | 10-B2 | 40 | 20 | 9,2 | 2,6 | 25,8 |
| T2-MG13 | 3/4"x7/16" | 12-B2 | 45 | 15 | 11,3 | 2,4 | 30,8 |
| T2-MG14 | 3/4"x7/16" | 12-B2 | 45 | 20 | 11,3 | 2,4 | 30,8 |
| T2-MG15 | 1"x17mm | 16-B2 | 65 | 15 | 16,5 | 3,5 | 48,4 |
| T2-MG18 | 1"x17mm | 16-B2 | 65 | 20 | 16,5 | 3,5 | 48,4 |
| T2-MG19 | 1 1/4"x3/4" | 20-B2 | 70 | 15 | 19 | 4,3 | 54,5 |
| T2-MG21 | 1 1/4"x3/4" | 20-B2 | 70 | 20 | 19 | 4,3 | 54,5 |
| T2-MG22 | 1 1/2"x1" | 24-B2 | 88 | 20 | 24,6 | 5,6 | 73 |
| T2-MG24 | 1 3/4"x31mm | 28-B2 | 105 | 25 | 30 | 6,9 | 89,6 |
| T2-MG25 | 2"x31mm | 32-B2 | 105 | 30 | 30 | 7,8 | 88,7 |

ASA chains

| Type | Chain | Ref. ASA | B [mm] | H [mm] | b [mm] | h [mm] | P [mm] |
|---------|------------|----------|--------|--------|--------|--------|--------|
| T2-MG51 | 3/8"x3/16" | ASA35,2 | 25 | 10 | 4 | 2,2 | 14,13 |
| T2-MG55 | 1/2"x5/16" | ASA40,2 | 35 | 10 | 7,1 | 2,3 | 21,48 |
| T2-MG56 | 1/2"x5/16" | ASA40,2 | 25 | 15 | 7,1 | 2,3 | 21,48 |
| T2-MG57 | 1/2"x5/16" | ASA40,2 | 35 | 20 | 7,1 | 2,3 | 21,48 |
| T2-MG59 | 5/8"x3/8" | ASA50,2 | 40 | 10 | 8,6 | 2,7 | 26,71 |
| T2-MG60 | 5/8"x3/8" | ASA50,2 | 40 | 15 | 8,6 | 2,7 | 26,71 |
| T2-MG61 | 5/8"x3/8" | ASA50,2 | 40 | 20 | 8,6 | 2,7 | 26,71 |
| T2-MG63 | 3/4"x1/2" | ASA60,2 | 45 | 10 | 11,9 | 3,4 | 34,68 |
| T2-MG64 | 3/4"x1/2" | ASA60,2 | 45 | 15 | 11,9 | 3,4 | 34,68 |
| T2-MG65 | 3/4"x1/2" | ASA60,2 | 45 | 20 | 11,9 | 3,4 | 34,68 |
| T2-MG67 | 1"x5/8" | ASA80,2 | 55 | 15 | 15,1 | 4,5 | 44,39 |
| T2-MG68 | 1"x5/8" | ASA80,2 | 55 | 20 | 15,1 | 4,5 | 44,39 |

T3 guides for triple roller chains

Guides for roller chains

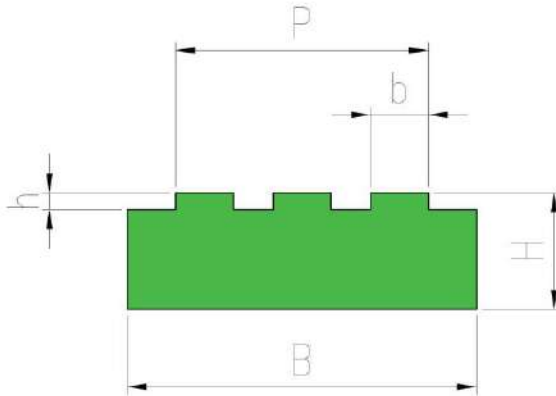

ISO chains

| Type | Chain | Ref. ISO | B [mm] | H [mm] | b [mm] | h [mm] | P [mm] |
|---------|------------|----------|--------|--------|--------|--------|--------|
| T3-MG01 | 3/8"x7/32" | 06-B3 | 35 | 10 | 5,4 | 1,5 | 25,9 |
| T3-MG05 | 1/2"x5/16" | 08-B3 | 45 | 10 | 7,4 | 2,2 | 35,2 |
| T3-MG06 | 1/2"x5/16" | 08-B3 | 45 | 15 | 7,4 | 2,2 | 35,2 |
| T3-MG07 | 1/2"x5/16" | 08-B3 | 45 | 20 | 7,4 | 2,2 | 35,2 |
| T3-MG09 | 5/8"x3/8" | 10-B3 | 55 | 10 | 9,2 | 2,6 | 42,4 |
| T3-MG10 | 5/8"x3/8" | 10-B3 | 55 | 15 | 9,2 | 2,6 | 42,4 |
| T3-MG11 | 5/8"x3/8" | 10-B3 | 55 | 20 | 9,2 | 2,6 | 42,4 |
| T3-MG13 | 3/4"x7/16" | 12-B3 | 60 | 15 | 11,3 | 2,4 | 50,2 |
| T3-MG14 | 3/4"x7/16" | 12-B3 | 60 | 20 | 11,3 | 2,4 | 50,2 |
| T3-MG15 | 1"x17mm | 16-B3 | 95 | 20 | 16,5 | 3,5 | 80,3 |

- Metallic profile is not included, it must be ordered separately. See "Steel profiles"

T1C guides for metallic profile for single roller chains

Roller chain guides

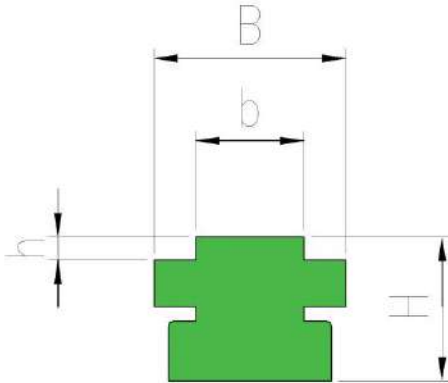

| Type | Chain | Ref. ISO | Metallic profile | BC [mm] | HC [mm] | B [mm] | H [mm] | b [mm] | h [mm] |
|----------|-------------|----------|------------------|---------|---------|--------|--------|--------|--------|
| T1C-MG31 | 3/8"x7/32" | 06-B1 | C-3 | 20 | 17 | 20 | 15 | 5,4 | 1,5 |
| T1C-MG33 | 1/2"x5/16" | 08-B1 | C-3 | 20 | 17 | 20 | 15 | 7,4 | 2,2 |
| T1C-MG34 | 5/8"x3/8" | 10-B1 | C-3 | 20 | 17 | 20 | 15 | 9,2 | 2,6 |
| T1C-MG35 | 3/4"x7/16" | 12-B1 | C-3 | 20 | 17 | 20 | 15 | 11,3 | 2,4 |
| T1C-MG36 | 1"x17mm | 16-B1 | C-5 | 28 | 18 | 28 | 15 | 16,5 | 3,5 |
| T1C-MG37 | 1 1/4"x3/4" | 20-B1 | C-9 | 38 | 27 | 38 | 20 | 19 | 4,3 |

• Metallic profile is not included, it must be ordered separately. See "Steel profiles"

E1 guides for single roller chains

Roller chain guides

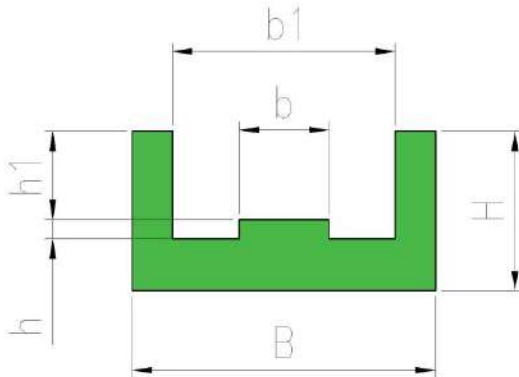

| Type | Chain | Ref. ISO | B [mm] | H [mm] | b [mm] | b1 [mm] | h [mm] | h1 [mm] |
|---------|------------|----------|--------|--------|--------|---------|--------|---------|
| E1-MG01 | 3/8"x7/32" | 06-B1 | 25 | 10 | 5,4 | 15 | 1,5 | 4,4 |
| E1-MG05 | 1/2"x5/16" | 08-B1 | 30 | 15 | 7,4 | 20 | 2,2 | 7,2 |
| E1-MG06 | 5/8"x3/8" | 10-B1 | 33 | 20 | 9,2 | 23 | 2,6 | 9,5 |
| E1-MG07 | 3/4"x7/16" | 12-B1 | 38 | 20 | 11,3 | 28 | 2,4 | 11,1 |
| E1-MG10 | 1"x17mm | 16-B1 | 51 | 25 | 16,5 | 41 | 3,5 | 16,5 |

E2 guides for double roller chains

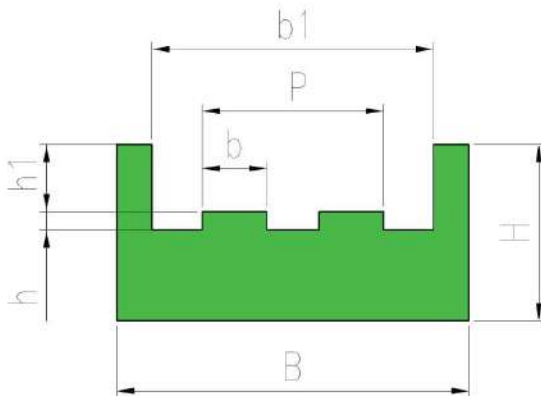

| Type | Chain | Ref. ISO | B [mm] | H [mm] | b [mm] | b1 [mm] | P [mm] | h [mm] | h1 [mm] |
|---------|------------|----------|--------|--------|--------|---------|--------|--------|---------|
| E2-MG01 | 3/8"x7/32" | 06-B2 | 36 | 15 | 5,4 | 26 | 15,8 | 1,5 | 4,4 |
| E2-MG05 | 1/2"x5/16" | 08-B2 | 45 | 20 | 7,4 | 35 | 21,4 | 2,2 | 7,2 |
| E2-MG06 | 5/8"x3/8" | 10-B2 | 50 | 25 | 9,2 | 40 | 25,8 | 2,6 | 9,5 |
| E2-MG07 | 3/4"x7/16" | 12-B2 | 56 | 25 | 11,3 | 46 | 30,8 | 2,4 | 11,1 |
| E2-MG10 | 1"x17mm | 16-B2 | 85 | 30 | 16,5 | 75 | 48,8 | 3,5 | 16,5 |

E1C guides for metallic profile for single roller chains

Roller chain guides

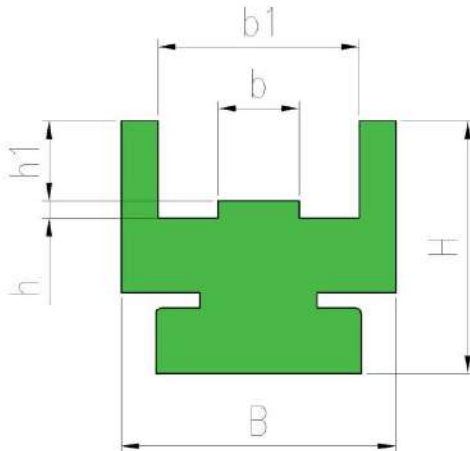

| Type | Chain | Ref. ISO | Metallic Profile | BC [mm] | HC [mm] | B [mm] | H [mm] | b [mm] | b1 [mm] | h [mm] | h1 [mm] |
|----------|------------|----------|------------------|---------|---------|--------|--------|--------|---------|--------|---------|
| E1C-MG01 | 3/8"x7/32" | 06-B1 | C-3 | 20 | 20 | 25 | 18 | 5,4 | 15 | 1,5 | 4,4 |
| E1C-MG05 | 1/2"x5/16" | 08-B1 | C-3 | 20 | 27 | 30 | 25 | 7,4 | 20 | 2,2 | 7,2 |
| E1C-MG06 | 5/8"x3/8" | 10-B1 | C-5 | 28 | 32 | 33 | 30 | 9,2 | 23 | 2,6 | 9,5 |
| E1C-MG07 | 3/4"x7/16" | 12-B1 | C-9 | 38 | 38,5 | 38 | 35 | 11,3 | 28 | 2,4 | 11,1 |
| E1C-MG10 | 1"x17mm | 16-B1 | C-9 | 38 | 43,5 | 51 | 40 | 16,5 | 41 | 3,5 | 16,5 |

• Metallic profile is not included, it must be ordered separately. See "Steel profiles"

E2C guides for metallic profile for double roller chains

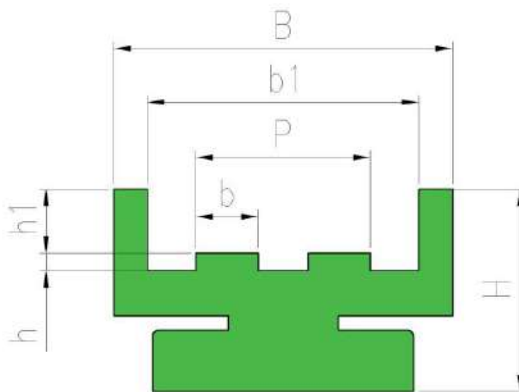

| Type | Chain | Ref. ISO | Metallic Profile | BC [mm] | HC [mm] | B [mm] | H [mm] | b [mm] | b1 [mm] | h [mm] | h1 [mm] | P [mm] |
|----------|------------|----------|------------------|---------|---------|--------|--------|--------|---------|--------|---------|--------|
| E2C-MG01 | 3/8"x7/32" | 06-B2 | C-5 | 28 | 22 | 36 | 18 | 5,4 | 26 | 1,5 | 4,4 | 15,8 |
| E2C-MG05 | 1/2"x5/16" | 08-B2 | C-9 | 38 | 33 | 45 | 25 | 7,4 | 35 | 2,2 | 7,2 | 21,4 |
| E2C-MG06 | 5/8"x3/8" | 10-B2 | C-9 | 38 | 37 | 50 | 30 | 9,2 | 40 | 2,6 | 9,5 | 25,8 |
| E2C-MG07 | 3/4"x7/16" | 12-B2 | C-9 | 38 | 38,5 | 56 | 35 | 11,3 | 46 | 2,4 | 11,1 | 30,8 |
| E2C-MG10 | 1"x17mm | 16-B2 | C-9 | 38 | 43,5 | 85 | 40 | 16,5 | 75 | 3,5 | 16,5 | 48,4 |

• Metallic profile is not included, it must be ordered separately. See "Steel profiles"

U guides for vertical roller chains

Roller chain guides

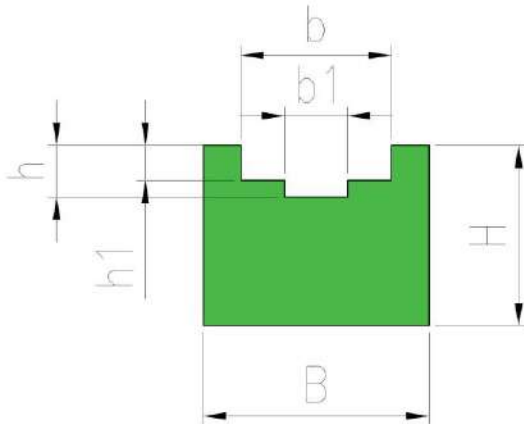

| Type | Chain | Ref. ISO | B [mm] | H [mm] | b [mm] | b1 [mm] | h [mm] | h1 [mm] |
|--------|-------------|----------|--------|--------|--------|---------|--------|---------|
| U-MG01 | 13/8"x7/32" | 06-B1 | 20 | 15 | 9,2 | 4 | 4,2 | 2,8 |
| U-MG02 | 1/2"x5/16" | 08-B1 | 25 | 15 | 12,7 | 5 | 4,8 | 3,5 |
| U-MG03 | 5/8"x3/8" | 10-B1 | 25 | 15 | 15,2 | 6 | 5,1 | 3,6 |
| U-MG04 | 3/4"x7/16" | 12-B1 | 25 | 20 | 16,7 | 7 | 5,7 | 3,9 |
| U-MG05 | 1"x17mm | 16-B1 | 35 | 25 | 24,4 | 9 | 10 | 8,4 |

UC guides for metallic profile for vertical roller chains

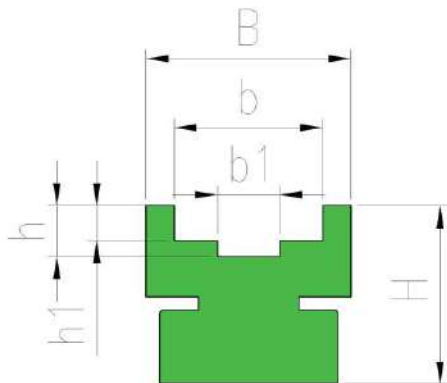

| Type | Chain | Ref. ISO | Metallc Profile | BC [mm] | HC [mm] | B [mm] | H [mm] | b [mm] | b1 [mm] | h [mm] | h1 [mm] |
|---------|------------|----------|-----------------|---------|---------|--------|--------|--------|---------|--------|---------|
| UC-MG32 | 1/2"x5/16" | 08-B1 | C-3 | 20 | 18 | 20 | 15 | 12,7 | 5 | 4,8 | 3,5 |
| UC-MG33 | 5/8"x3/8" | 10-B1 | C-3 | 20 | 18 | 23 | 15 | 15,2 | 6 | 5,1 | 3,6 |
| UC-MG34 | 3/4"x7/16" | 12-B1 | C-3 | 20 | 23 | 23 | 20 | 16,7 | 7 | 5,7 | 3,9 |
| UC-MG35 | 1"x17mm | 16-B1 | C-5 | 28 | 28 | 32 | 25 | 24,4 | 8 | 10 | 8,4 |

- Metallic profile is not included, it must be ordered separately. See "Steel profiles"

BL guides for vertical single roller chains

Roller chain guides

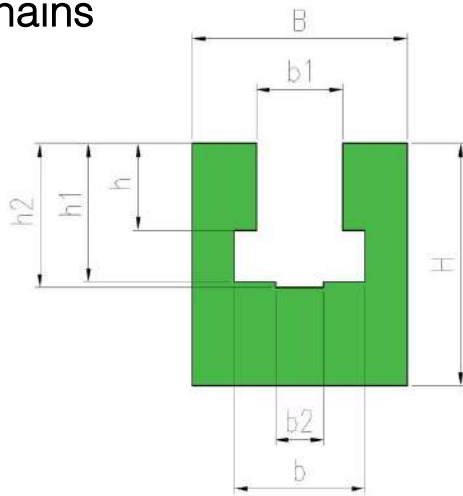

| Type | Chain | Ref. ISO | B [mm] | H [mm] | b [mm] | b1 [mm] | b2 [mm] | h [mm] | h1 [mm] | h2 [mm] |
|---------|-------------|----------|--------|--------|--------|---------|---------|--------|---------|---------|
| BL-MG01 | 3/8"x7/32" | 06-B1 | 20 | 25 | 9,3 | 6,6 | 4 | 5,6 | 8,7 | 10 |
| BL-MG05 | 1/2"x5/16" | 08-B1 | 24 | 30 | 12,8 | 8,7 | 5 | 7,6 | 11,5 | 13,5 |
| BL-MG09 | 5/8"x3/8" | 10-B1 | 30 | 35 | 15,4 | 10,4 | 6 | 9,5 | 13,5 | 14,8 |
| BL-MG15 | 3/4"x7/16" | 12-B1 | 40 | 35 | 16,9 | 12,3 | 7 | 11,5 | 15,9 | 17,5 |
| BL-MG18 | 1"x17mm | 16-B1 | 40 | 45 | 24,4 | 16,1 | 9 | 16,1 | 25,7 | 26,8 |
| BL-MG21 | 1 1/4"x3/4" | 20-B1 | 50 | 50 | 27,5 | 19,3 | 11 | 19,4 | 29,3 | 31,2 |
| BL-MG24 | 1 1/2"x1" | 24-B1 | 60 | 60 | 36,5 | 25,7 | 16 | 25,2 | 38,2 | 40,1 |
| BL-MG25 | 1 3/4"x31mm | 28-B1 | 60 | 70 | 41,5 | 28,3 | 17 | 30,8 | 46,9 | 48,9 |
| BL-MG30 | 2"x31mm | 32-B1 | 70 | 75 | 44,5 | 29,6 | 19 | 30,8 | 47,3 | 53 |

BLC guides for metallic profile for vertical single roller chains

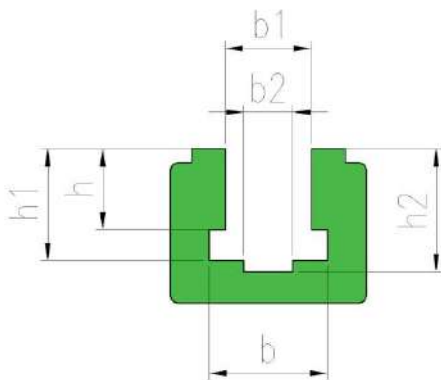

| Type | Chain | Ref. ISO | Metallic Profile | BC [mm] | HC [mm] | b [mm] | b1 [mm] | b2 [mm] | h [mm] | h1 [mm] | h2 [mm] |
|----------|-------------|----------|------------------|---------|---------|--------|---------|---------|--------|---------|---------|
| BLC-MG01 | 3/8"x7/32" | 06-B1 | C-10 | 30 | 24 | 9,3 | 6,6 | 4 | 5,6 | 8,7 | 10 |
| BLC-MG05 | 1/2"x5/16" | 08-B1 | C-10 | 30 | 24 | 12,8 | 8,7 | 5 | 7,6 | 11,5 | 13,5 |
| BLC-MG09 | 5/8"x3/8" | 10-B1 | C-10 | 30 | 24 | 15,4 | 10,4 | 6 | 9,5 | 13,5 | 14,8 |
| BLC-MG15 | 3/4"x7/16" | 12-B1 | C-10 | 30 | 24 | 16,9 | 12,3 | 7 | 11,5 | 15,9 | 17,5 |
| BLC-MG18 | 1"x17mm | 16-B1 | C-11 | 45 | 40 | 24,4 | 16,1 | 9 | 16,1 | 25,7 | 26,8 |
| BLC-MG21 | 1 1/4"x3/4" | 20-B1 | C-11 | 45 | 40 | 27,5 | 19,3 | 11 | 19,5 | 29,3 | 31,2 |

• Metallic profile is not included, it must be ordered separately. See "Steel profiles"

KC guides for metallic profile for vertical single roller chains

Roller chain guides

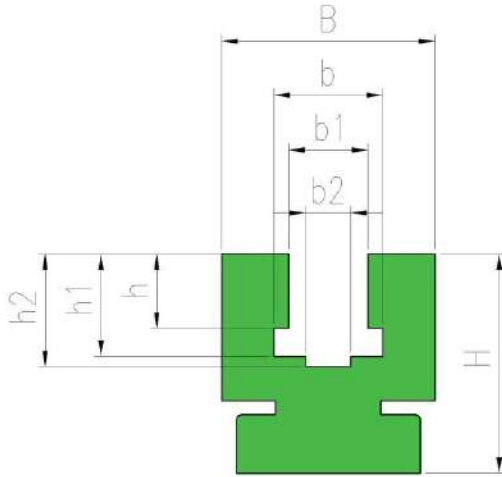

| Type | Chain | Ref. ISO | Metallic Profile | BC [mm] | HC [mm] | B [mm] | H [mm] | b [mm] | b1 [mm] | b2 [mm] | h [mm] | h1 [mm] | h2 [mm] |
|---------|------------|----------|------------------|---------|---------|--------|--------|--------|---------|---------|--------|---------|---------|
| KC-MG01 | 3/8"x7/32" | 06-B1 | C-3 | 20 | 21 | 20 | 17,5 | 9,3 | 6,6 | 4 | 5,6 | 8,7 | 10 |
| KC-MG02 | 1/2"x5/16" | 08-B1 | C-5 | 28 | 32 | 24 | 27,5 | 12,8 | 8,7 | 5 | 7,6 | 11,5 | 13,5 |
| KC-MG03 | 5/8"x3/8" | 10-B1 | C-5 | 28 | 32 | 24 | 27,5 | 15,4 | 10,4 | 6 | 9,5 | 13,5 | 14,8 |
| KC-MG04 | 3/4"x7/16" | 12-B1 | C-9 | 38 | 42 | 33 | 34 | 16,9 | 12,3 | 7 | 11,5 | 15,9 | 17,5 |
| KC-MG05 | 1"x17mm | 16-B1 | C-10 | 30 | 50 | 38 | 40 | 24,4 | 16,1 | 9 | 16,1 | 25,7 | 26,8 |

- Metallic profile is not included, it must be ordered separately. See "Steel profiles"

R guides for round belts

Round belt guides

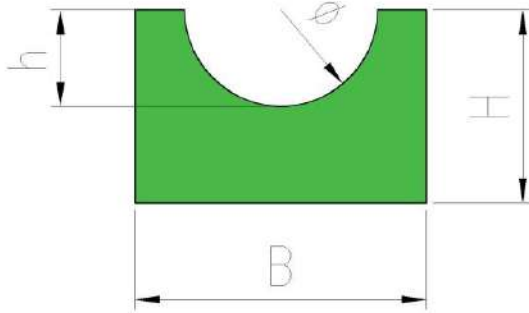

| Type | Ø Round belt [mm] | B [mm] | H [mm] | h [mm] | Ø [mm] |
|--------|-------------------|--------|--------|--------|--------|
| R-MG01 | 4 | 15 | 10 | 2 | 4 |
| R-MG03 | 5 | 15 | 10 | 2,5 | 5 |
| R-MG05 | 6 | 20 | 10 | 3 | 6 |
| R-MG07 | 8 | 20 | 10 | 4 | 8 |
| R-MG09 | 10 | 25 | 12 | 5 | 10 |
| R-MG11 | 12 | 25 | 12 | 6 | 12 |
| R-MG13 | 15 | 25 | 15 | 7,5 | 15 |
| R-MG15 | 20 | 30 | 20 | 10 | 20 |

RC guides for metallic profile for round belts

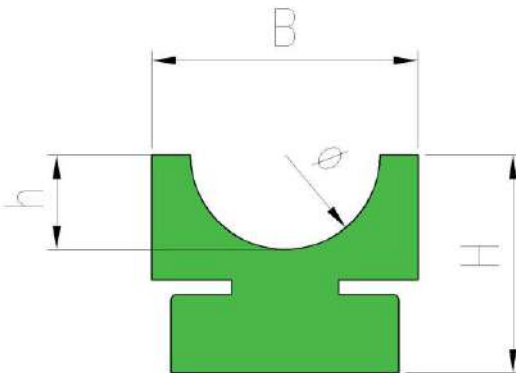

| Type | Metallic profile | Ø Round belt [mm] | BC [mm] | HC [mm] | B [mm] | H [mm] | h [mm] | Ø [mm] |
|---------|------------------|-------------------|---------|---------|--------|--------|--------|--------|
| RC-MG02 | C-3 | 4 | 20 | 14 | 20 | 10 | 2 | 4 |
| RC-MG04 | C-3 | 5 | 20 | 14 | 20 | 10 | 2,5 | 5 |
| RC-MG06 | C-3 | 6 | 20 | 14 | 20 | 10 | 3 | 6 |
| RC-MG08 | C-3 | 8 | 20 | 14 | 20 | 10 | 4 | 8 |
| RC-MG10 | C-5 | 10 | 28 | 18 | 25 | 15 | 5 | 10 |
| RC-MG12 | C-5 | 12 | 28 | 18 | 25 | 15 | 6 | 12 |
| RC-MG14 | C-5 | 15 | 28 | 20 | 25 | 15 | 7,5 | 15 |
| RC-MG16 | C-5 | 20 | 28 | 24 | 28 | 20 | 10 | 20 |

• Metallic profile is not included, it must be ordered separately. See "Steel profiles"

V guides for V-belts

V-belt guides

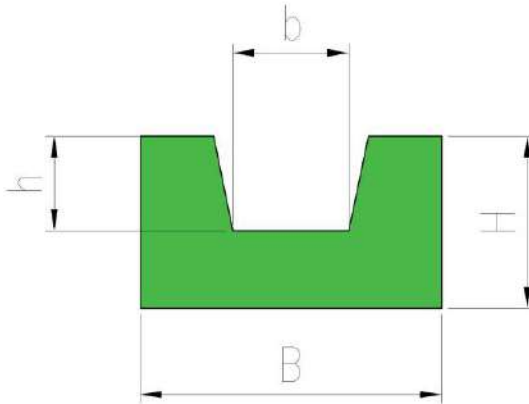

| Type | V-Belt section | V-Belt width [mm] | B [mm] | H [mm] | b [mm] | h [mm] |
|--------|----------------|-------------------|--------|--------|--------|--------|
| V-MG01 | Z | 10 | 20 | 10 | 6,5 | 3 |
| V-MG03 | A | 13 | 20 | 12 | 8 | 5 |
| V-MG05 | SPB | 15 | 25 | 12 | 9,5 | 5 |
| V-MG07 | B | 17 | 30 | 15 | 10,5 | 8 |
| V-MG09 | C | 22 | 35 | 20 | 13,5 | 11 |
| V-MG11 | D | 30 | 40 | 25 | 19 | 13 |

VC guides for metallic profile for V-belts

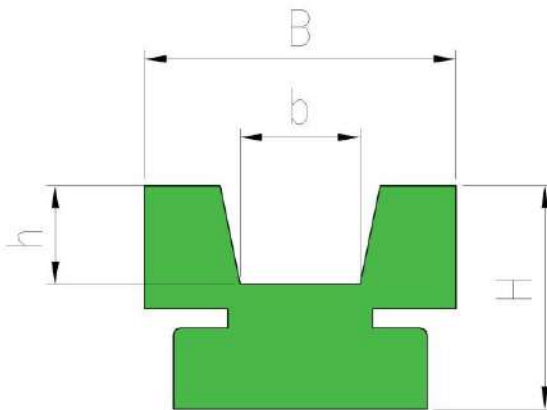

| Type | Metallic profile | V-Belt section | V-Belt width [mm] | BC [mm] | HC [mm] | B [mm] | H [mm] | b [mm] | h [mm] |
|---------|------------------|----------------|-------------------|---------|---------|--------|--------|--------|--------|
| VC-MG02 | C-3 | Z | 10 | 20 | 17 | 20 | 15 | 6,5 | 3 |
| VC-MG04 | C-3 | A | 13 | 20 | 17 | 20 | 15 | 8 | 5 |
| VC-MG06 | C-5 | SPB | 15 | 28 | 24 | 25 | 20 | 9,5 | 5 |
| VC-MG08 | C-5 | B | 17 | 28 | 24 | 30 | 20 | 10,5 | 8 |
| VC-MG10 | C-9 | C | 22 | 38 | 32 | 35 | 25 | 13,5 | 11 |
| VC-MG12 | C-9 | D | 30 | 38 | 35 | 40 | 25 | 19 | 13 |

• Metallic profile is not included, it must be ordered separately. See "Steel profiles"

PC slide rails for metallic profile

Flat belt guides

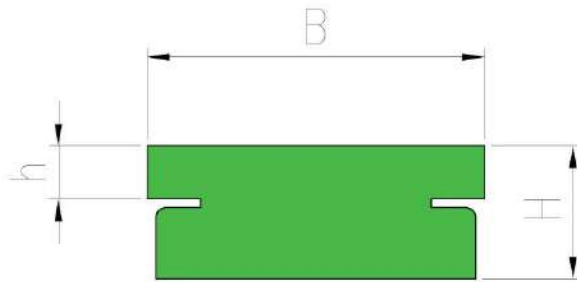

| Type | Metallic profile | HC [mm] | B [mm] | H [mm] | h [mm] |
|---------|------------------|---------|--------|--------|--------|
| PC-MG01 | C-3 | 14 | 20 | 10 | 4 |
| PC-MG02 | C-3 | 17 | 20 | 15 | 7 |
| PC-MG03 | C-3 | 22 | 20 | 20 | 12 |
| PC-MG04 | C-5 | 15 | 28 | 10 | 3 |
| PC-MG05 | C-5 | 18 | 28 | 15 | 6 |
| PC-MG06 | C-5 | 24 | 28 | 20 | 12 |
| PC-MG07 | C-9 | 21 | 38 | 10 | 3 |
| PC-MG08 | C-9 | 24 | 38 | 15 | 6 |
| PC-09 | C-9 | 30 | 38 | 20 | 12 |

- Metallic profile is not included, it must be ordered separately. See "Steel profiles"

F and FC slide rails for flat profile

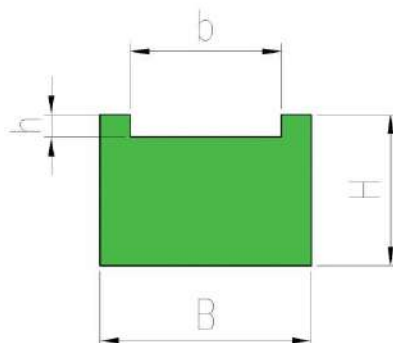

- Rails available in FC version – with metallic profile, not included – or F version – without metallic profile. Custom made according to the dimensions required by the customer

Steel profiles for the guides

Steel profiles

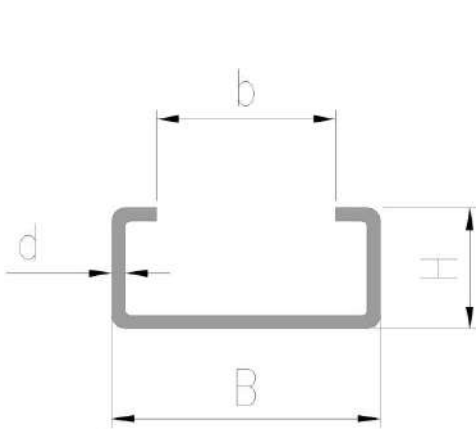

C-MG3/CI-MG3, C-MG5/CI-MG5, C-MG9/CI-MG9

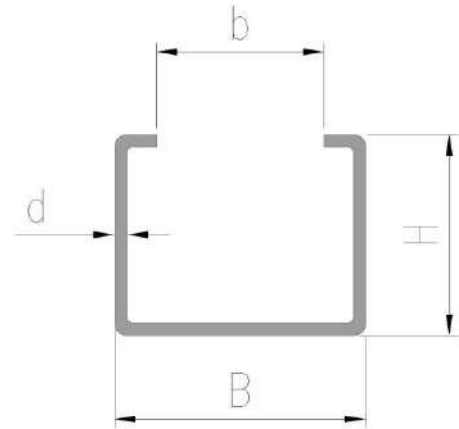

C-MG10/CI-MG10, C-MG11/CI-MG11

| Type | Material | Weight [kg/m] | B [mm] | H [mm] | b [mm] | d [mm] |
|--------|------------------|---------------|--------|--------|--------|--------|
| C-MG3 | Galvanized Steel | 0,43 | 20 | 10 | 10 | 1,5 |
| C-MG5 | Galvanized Steel | 0,85 | 28 | 12 | 14 | 1,5 |
| C-MG9 | Galvanized Steel | 0,98 | 38 | 18 | 22 | 1,5 |
| C-MG10 | Galvanized Steel | 0,94 | 30 | 24 | 20 | 1,5 |
| C-MG11 | Galvanized Steel | 2,05 | 45 | 40 | 31 | 1,5 |

| Type | Material [Aisi 304] | Weight [kg/m] | B [mm] | H [mm] | b [mm] | d [mm] |
|---------|---------------------|---------------|--------|--------|--------|--------|
| CI-MG3 | Stainless steel | 0,43 | 20 | 10 | 10 | 1,5 |
| CI-MG5 | Stainless steel | 0,85 | 28 | 12 | 14 | 1,5 |
| CI-MG9 | Stainless steel | 0,98 | 38 | 18 | 22 | 1,5 |
| CI-MG10 | Stainless steel | 0,94 | 30 | 24 | 20 | 1,5 |
| CI-MG11 | Stainless steel | 2,05 | 45 | 40 | 31 | 1,5 |

• Standard lengths are 3mt and 6mt